



Tritton Mines

December 2011





Contents

1	Executive Summary
2	Geology
3	Mining Operations
4	Processing
5	Marketing
6	Health, Safety and Environment
7	Business Plan



Location Summary

Key Details

Description

Location	Central NSW, Girilambone, 50 km North East of Nyngan. Tritton Site, 20 km North of Hermidale
Access	Via Mitchell and Barrier Highways
Climate	Dry continental
Topography	Flat, undulating, localised ridges
Temperature	Mean Daily, 25.7 C. January hottest month with average daily max of 34.2 C. Winters are mild, July is coldest month with average daily max of 16.4 C
Rainfall	Rainfall distributed evenly throughout year, slight elevation in summer months. Mean rainfall pa of 430 mm
Evaporation	Averages 2,050 mm pa
Land use	Cleared grazing and cropping
Power	Grid power
Water	Pumped from Gunningbar Creek under licence



Tenement	Status	Area	Tenement	Status	Area
ML1280	Granted	322.3 ha	EL6126	Renewal Pending	317 units
ML 1383	Granted	1311 ha	EL6785	Renewal Pending	80 units
ML1544	Granted	1400 ha	EL6645	Granted	67 units
MPL 294	Granted	3.58 ha	EL4962	Granted	123 units
MPL 295	Granted	89.23 ha	ELA4389	Application	23 units
EL6105	Granted	13 units	ELA4419	Application	100 units
EL6346	Granted	78 units			



Project Summary

Tritton Mines Comprises

Tritton Decline	Mechanised underground (decline) copper mine operating at 0.85 to 1.1 Mtpa
Tritton Concentrator	1.6 Mtpa copper concentrate processing plant located at Tritton.
Copper Cement Plant	1,100 tpa Cu cement plant at Murrawombie
Murrawombie Decline	Pending restart, mechanised underground decline mine with planned 500,000 tpa production rate located 22 km from Tritton via sealed road.
North East Decline	Mechanised underground (decline) copper mine operating at 400,000 to 500,000 tpa located in the northern mines area, 5 km north of Murrawombie.
Larsens Decline	In development, mechanised underground (decline) copper mine adjacent to and accessed from the North East decline.
Budgery Project	Advanced copper project, located 13 km south of Tritton undergoing preliminary feasibility studies.
Avoca Tank	Recent VMS discovery located 2 km north of the North East Decline, undergoing further drilling and preliminary scoping studies. Mining Lease application in progress.
Regional Exploration	1,757 km ² of prospective VMS terrain

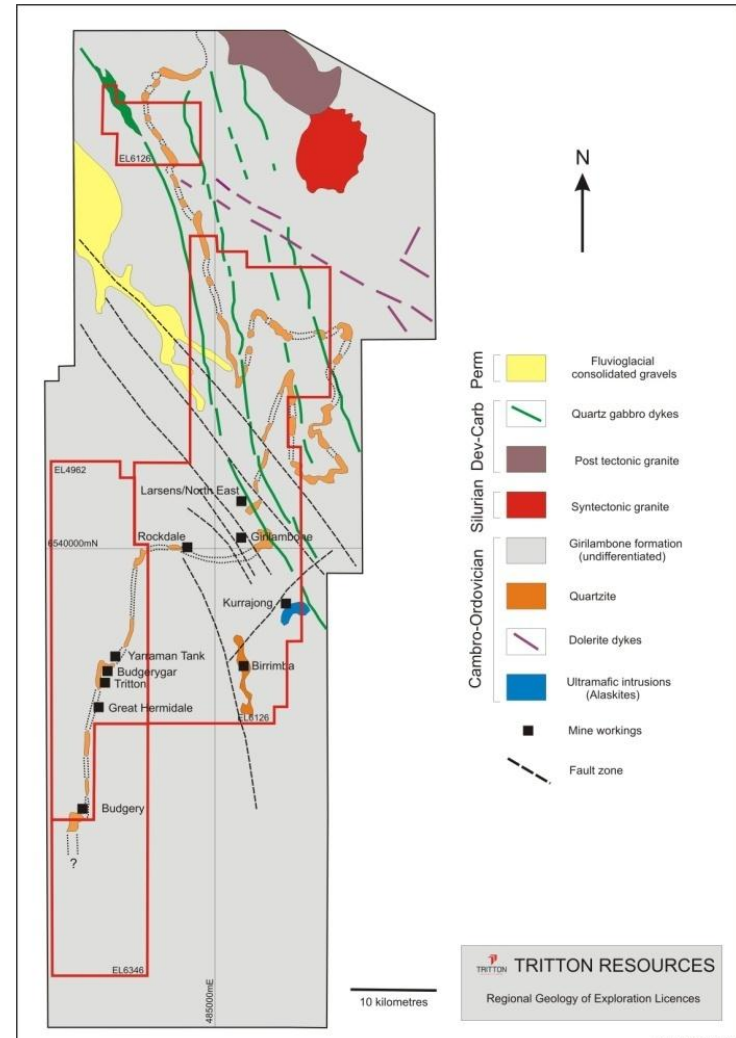



Project Summary

Tritton Mines Comprises

Ownership	Tritton Mines operating since 2004 and owned 100% by Straits Resources Limited and its predecessor company since 2006.	
Mining	Tritton	Mechanised transverse open stoping with pastefill.
	North East	Mechanised longitudinal open stoping
	Murrawombie	Planned mechanised longitudinal open stoping.
	Larsens	Planned mechanised longitudinal open stoping
	Budgery	Planned conventional open pit, truck / shovel.
Avoca Tank	Drilling. In preliminary planning.	
Contractor	Mining undertaken as owner – operate.	
Product	Current minimum plan of 25,000 tpa 25% Cu concentrate for 7 years reserve life (15 year resource life).	
Offtake	Onerous concentrate offtake agreement was bought out Dec 2011. From January 2012 Tritton will receive market related TC/RC's.	
HSEC	Corporate standards, externally audited.	

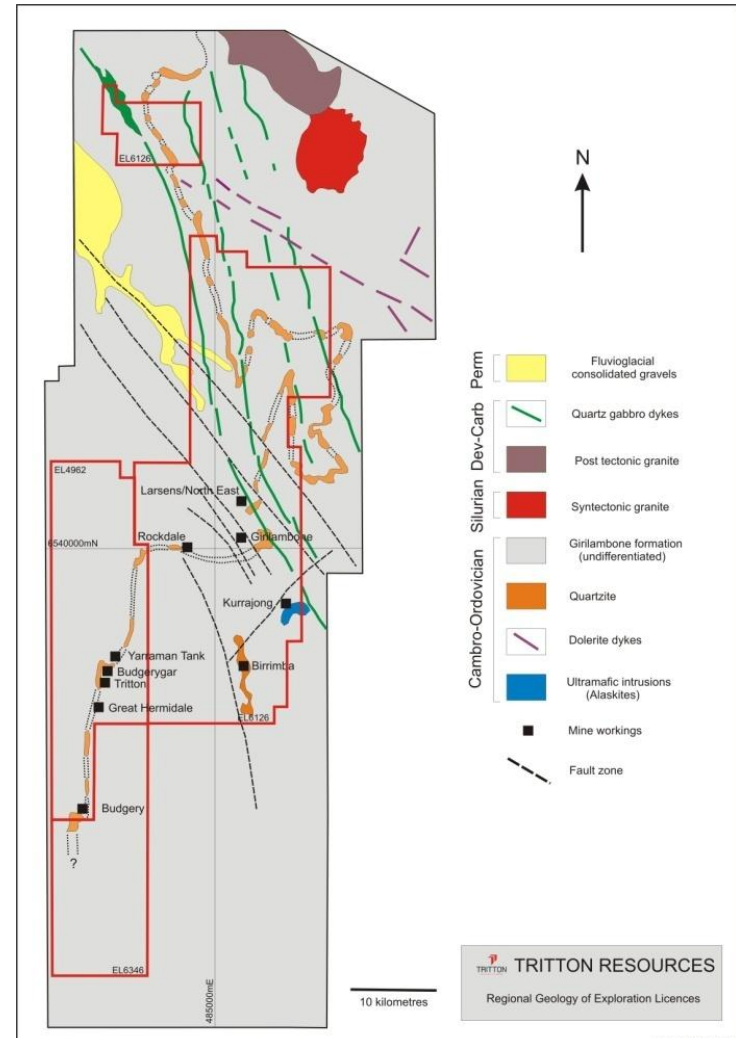



Introduction

- ❑ The Tritton mine was officially opened on 8 April 2005 which coincided with the first shipment of copper concentrate from the Port of Newcastle.
- ❑ Straits (through its predecessor company) acquired control of Tritton Resources Limited by takeover offer in late 2005.
- ❑ Mining is owner operate, undertaken at the Tritton Decline using a traverse primary and secondary open stoping method that recovers ~ 95% of the mineable resource, at a current rate of 850,000 tpa, increasing to 1.1 Mtpa.
- ❑ Mining at the North East Decline is undertaken using longitudinal open stoping with partial rock fill, currently at a rate of 480,000 tpa. North East Decline ore is trucked to the processing plant at Tritton.
- ❑ At the Tritton processing plant combined ore feed is fed to a conventional concentrate processing plant, which was expanded from 900,000 tpa capacity to 1.6 Mtpa in 2007.

Combined Tritton and North East Decline Production History	2005 CY	2006 CY	2007 CY	6 months June 2008	2009 FY	2010 FY	2011 FY
Tonnes Mined	364,893	790,940	680,439	343,606	932,532	911,539	1,160,476
Grade Mined	4.01	3.21	3.10	2.53	2.72	2.35	2.11
Copper Mined	14,695	23,801	21,100	8,685	25,404	21,451	24,486
Recovery	89.6	93.1	93.8	93.3	94.1	94.2	95.1
Concentrate Tonnes	75,640	91,569	74,445	33,282	95,026	81,183	94,483
Concentrate Grade	25.43	25.21	24.92	25.15	24.95	24.91	25.0
Copper in Concentrate	19,296	23,088	18,549	8,372	24,111	20,847	23,354



Sulphide Resources and Reserves (at 30th June 2011)

Tritton Mineral Resource History

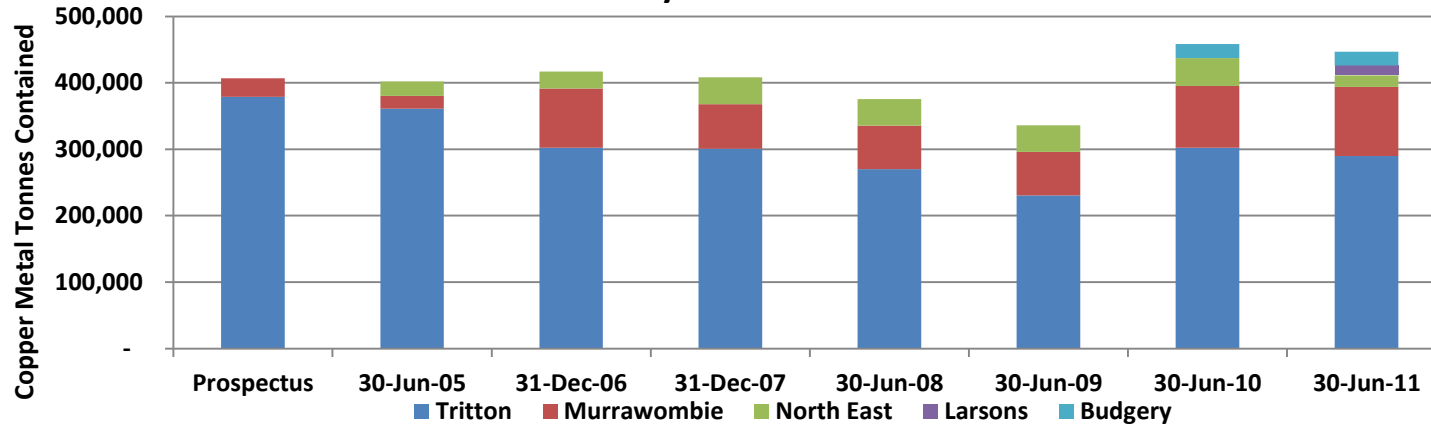

Resources	Measured	Indicated	Inferred	Total
Tonnes	2,620,000	19,950,000	7,336,000	29,908,000
Grade	2.47	1.54	1.36	1.58
Copper Metal	64,700	307,300	100,000	472,000

Reserves	Proven	Probable	Total
Tonnes	1,670,000	8,730,000	10,400,000
Grade	2.30	1.60	1.80
Copper Metal	38,400	139,680	187,200
Rec Copper Metal	37,000	135,000	172,000



Operational Summary



Exploration

Access and Mine Development

Ore Development

Stope
Drilling

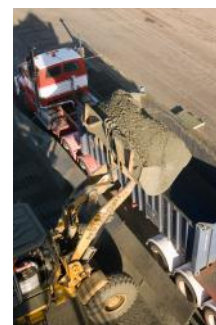
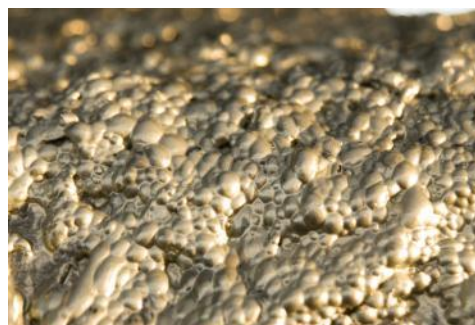

Bogging

1.6 Mtpa Processing Plant

Froth Concentration

Container Loading to Train



Concentrate Quality

Current Indicative Concentrate Quality

Element	Assay	Element	Assay
Copper %	25	SiO ₂ %	8
Gold g/t	0.7	MgO %	2
Silver g/t	50	As ppm	80
Fe %	28	Bi ppm	4
S %	31	Cd ppm	70
Zn %	1.5	F ppm	120
Ni ppm	33	Hg ppm	2
Co ppm	300	Sb ppm	40
Cl ppm	120	Se ppm	165



Geology



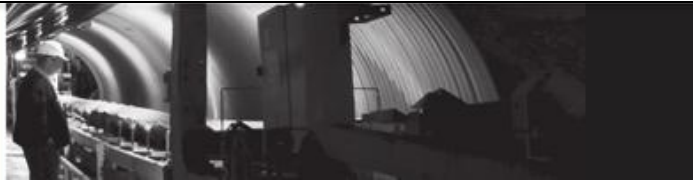

Geology

- ❑ The Tritton regional exploration areas have revealed structural and lithochemical terrains favourable for discovery of clustered volcanic massive sulphide (VMS) ore bodies of which seven have been discovered / developed to date.
- ❑ Prior to the discovery of Tritton in 1995, exploration was primarily focused on the discovery of additional copper oxide reserves to feed the Girilambone heap leach, SX/EW plant. Prior to Tritton's discovery (using Transient Electromagnetism to find sulphides in addition to the up-dip oxides), the exploration partners identified over two dozen oxide prospects, some undrilled, many with ore grade intercepts and some with copper oxide mineral resources. These prospects were essentially left undrilled at depth, with attention focused on Tritton and to a lesser extent Girilambone and North East. These identified prospects now represent outstanding undrilled sulphide targets.
- ❑ More recently, more modern geological investigation and analysis techniques is identifying the potential for the discovery of new VMS systems within the permit area.
- ❑ This regional sulphide geological potential is only now being tested.

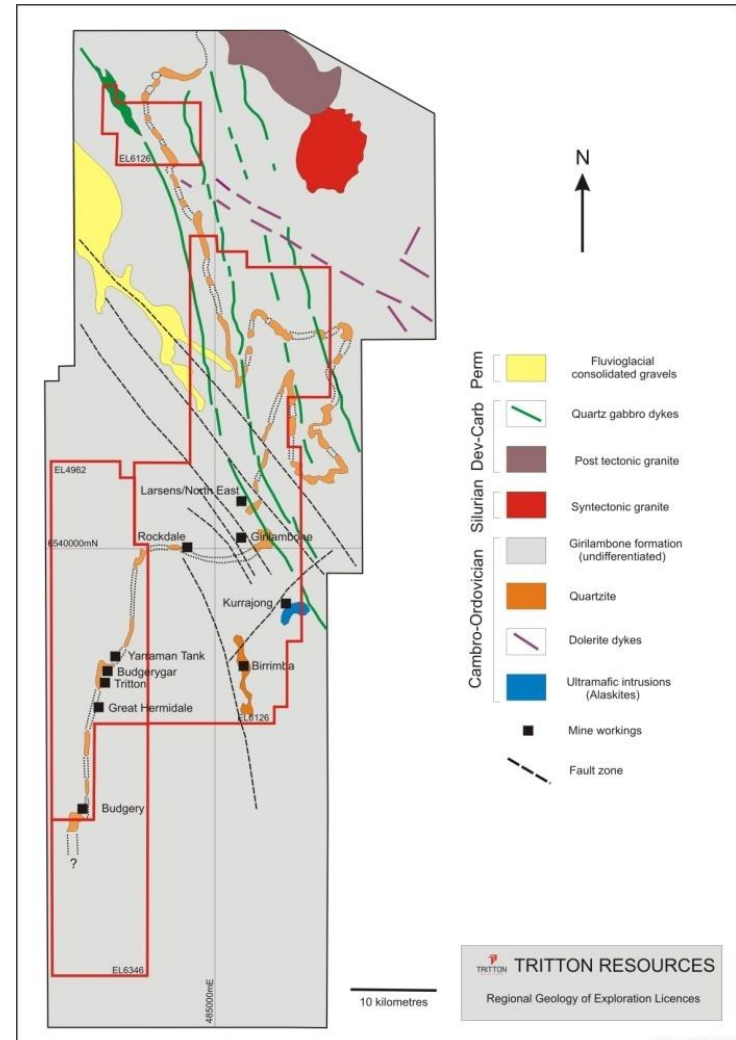



Geology

- ❑ Extremely prospective terrain.
- ❑ Detailed stratigraphic and petrographic logging of core since 2009 (Girilambone re-logging, Tritton Deeps Drilling Project), and geological benchmarking has allowed staff to conclusively categorise the Tritton deposits into a Besshi VMS deposit class.
- ❑ Prospective Complexes characterised by mafic horizons, oxide/sulphide occurrences, magnetic/geophysical and geochemical signatures.
- ❑ Besshi systems characterised as;
 - Exhalative – synchronous with deposition
 - Banded sulphide zones with massive sulphide lenses
 - Dominantly pyrite systems with lesser chalcopyrite, sphalerite and gold
 - Copper grades average 1 – 3% and zinc grades up to 3% but commonly 0.2 to 0.5%
 - Lithological and structural control on mineralisation
- ❑ Early results from Avoca Tanks show high grade copper and gold intercepts (up to 6% Cu and 3 g/t Au) and otherwise typical Besshi characteristics.

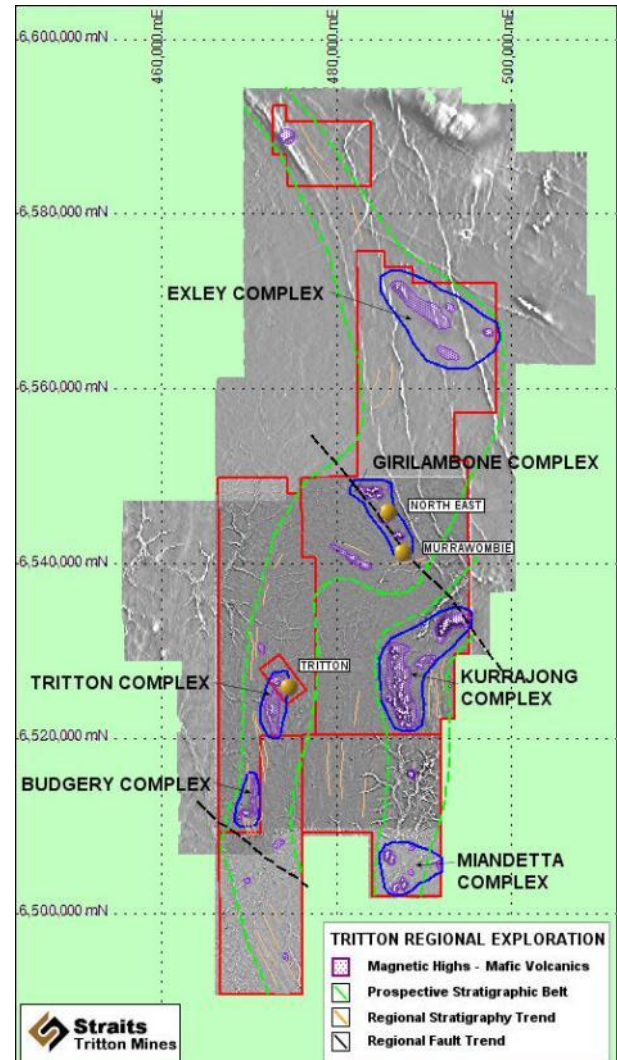



Geology – Tritton Mine

- ❑ Tritton ore body is a large tabular sheet of laminated and banded sulphides hosted within highly siliceous and hydrothermally altered meta-sediments underlain by magnesium chlorite rich and stringer sulphide veined alteration zones.
- ❑ Plunging to the SE at 30 to 50 degrees, and drilled to 1,250 m below surface, the orebody is open at depth. Variable thickness of between 3 – 5 metres in the upper zone, to 100 metres thick at depth and a strike length of 250 to 300 m in the upper levels.
- ❑ The deposit thins at its lateral extents and there has been no drilling outside the immediate Tritton corridor. Exploration for strike repetitions is part of the exploration strategy.
- ❑ The orebody exhibits complex recumbent and overturned late stage folding, particularly evident in the upper zone.
- ❑ The massive sulphide mineralisation at Tritton is dominated by fine grained pyrite with subordinate chalcopyrite and lesser sphalerite, contain moderate Au grades of 0.5 to 1 g/t and Ag from 20 to 40 g/t.
- ❑ With depth the orebody changes from massive sulphide dominant to massive sulphides underlain by a banded sulphide sequence. A lower grade sequence occurs as internal waste with depth.
- ❑ Underexplored below 1,250 metres and completely open at depth.

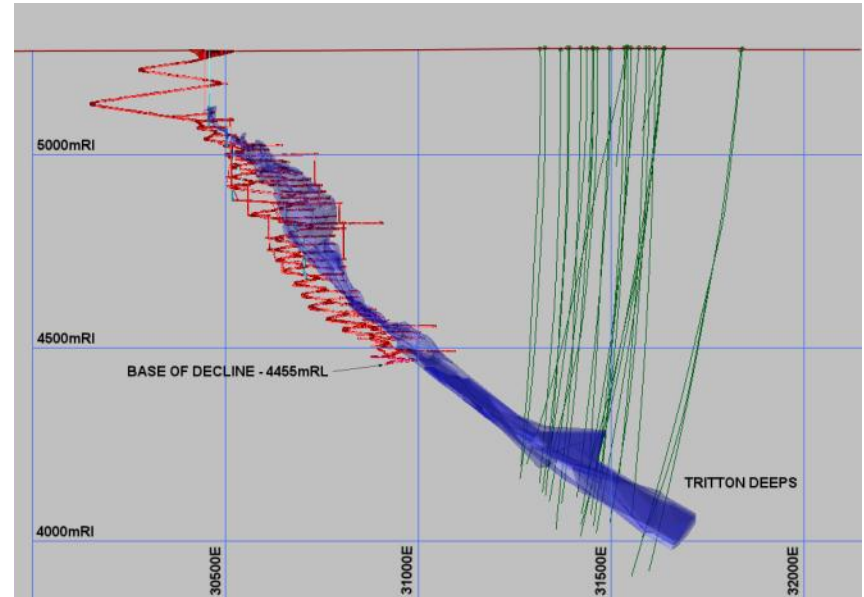



Geology – Murrawombie Mine

- ❑ The Murrawombie mine is located 2 km west of Girilambone, with mining of the oxide open cut completed in 1997. Two levels of mine development were completed in 2008 before operations were suspended due to the GFC.
- ❑ The deposit is a geological VMS analogue to Tritton, exhibiting exhalative laminated siliceous sulphides below pyrite-chalcopyrite massive sulphides hosted within an intensely silicified schist.
- ❑ Disseminated sulphides occur towards the base of the schist.
- ❑ The deposit is drilled to approximately 600m and is open at depth.

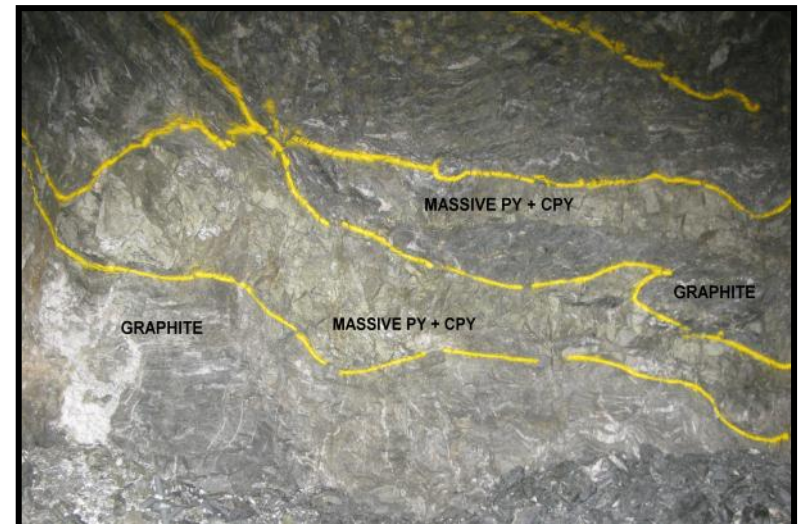
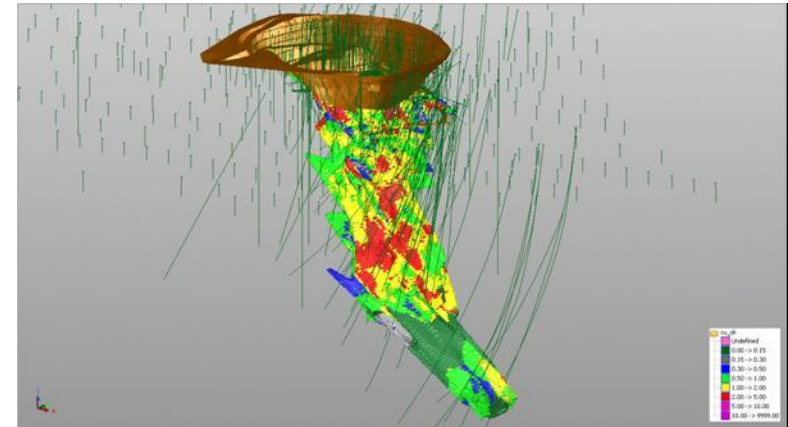



Geology – North East and Larsens Mines

- ❑ The North East and Larsens Mines are located 5 km north of Murrawombie.
- ❑ Copper mineralisation at the North East Mine is hosted by weakly chlorite altered and silicified schist in a massive to banded pyrite – chalcopyrite lens that dips moderately to the east.
- ❑ A higher grade core to the mineralisation is continuous across strike and plunge having a strike approximately 100 m and a width of 10 m.
- ❑ Economic mineralisation strike is in the order of 175 m with a horizontal width averaging 30 m. The deposit is open at depth and resources, limited only by drilling.
- ❑ Copper sulphide mineralisation, primarily chalcocite, at the adjacent Larsens Mine is hosted by weakly chlorite altered schist in three discrete, massive to banded pyrite – chalcopyrite lenses that dip steeply to the east and plunge moderately to the south – east. The central lens is the largest defined to date and comprises two sub parallel lenses each several metres thick with strike lengths of 40m.
- ❑ The deposit is open at depth with very limited drilling. Mining operations have recommenced to establish underground drilling positions for resource extension.

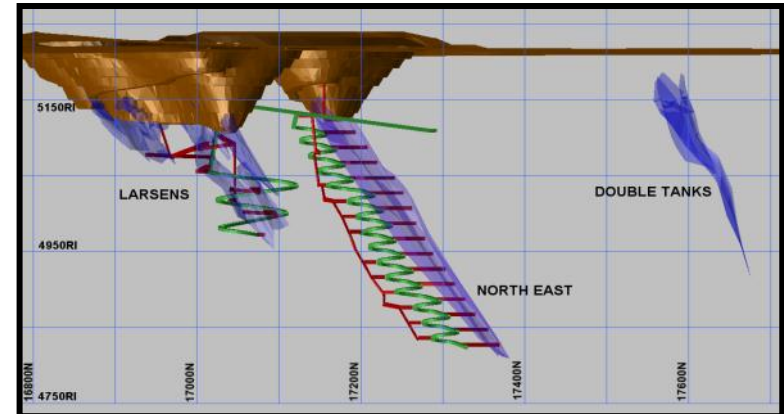



Geology – Budgery

- ❑ Budgery is located 5 km north of Hermidale, much like Avoca Tank, small scale workings dating to 1905 define the oxide mineralisation.
- ❑ Limited drilling to date has tested two massive and banded sulphide lenses below the oxides, dipping at 40 degrees to the south east, with a strike length of approximately 200 m.
- ❑ Oxide mineralisation (malachite / azurite) extends to 70 m, above transitional chalcocite to 150 m, trending into pyritic primary sulphides up to 40 m thick.
- ❑ Recent IP geophysics has provided improved definition of targets at Burgery, and drilling will be undertaken down dip and along strike to test co-incident IP / Magnetic anomalies that may represent repetitions.

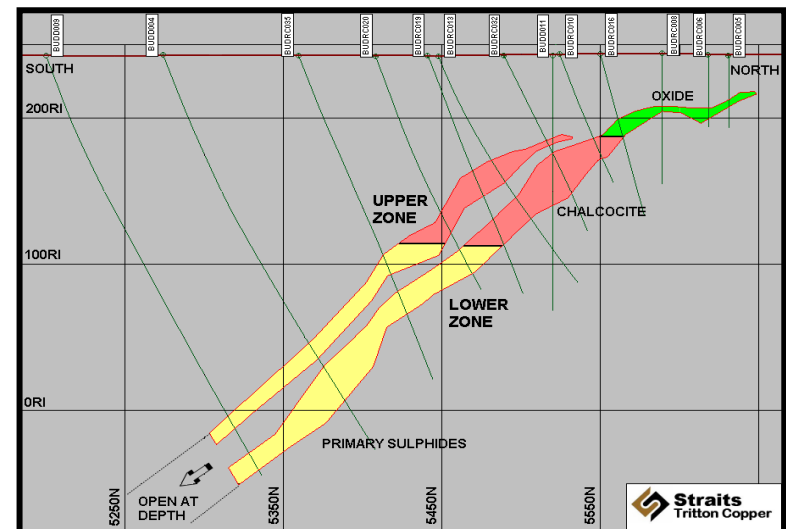



Geology – Avoca Tank - Exploration

- ❑ The Avoca Tank high grade lens was discovered in August 2011 by targeting known oxide / sulphide occurrences, with coincident geochemical and geophysical responses at the Avoca Tank Complex.
- ❑ Strong magnetic signatures (potentially magnetite alteration) and mafic horizons are used to target the presence of sulphide mineralisation. This association has been identified with the high grade mineralisation discovered at Avoca Tank.
- ❑ Drilling and evaluation is currently ongoing. Mining Lease applications have commenced.
- ❑ Exploration within the Tritton Mines leases is now focused on applying updated geophysical and geochemical (RAB) techniques to revised geological concepts and success in defining the Avoca Tank sulphide system.

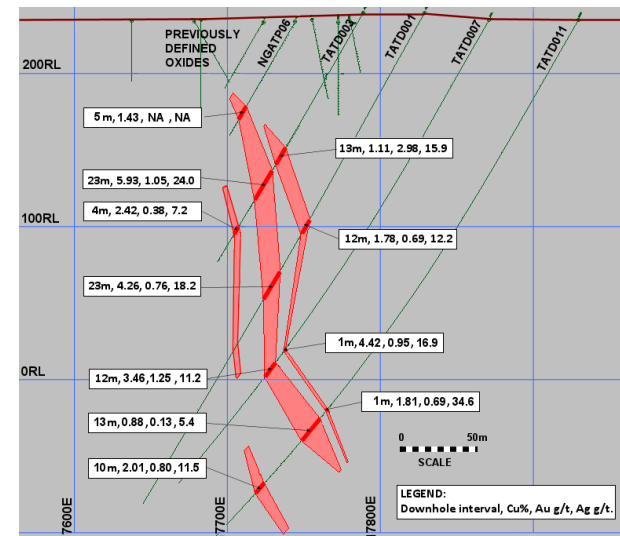
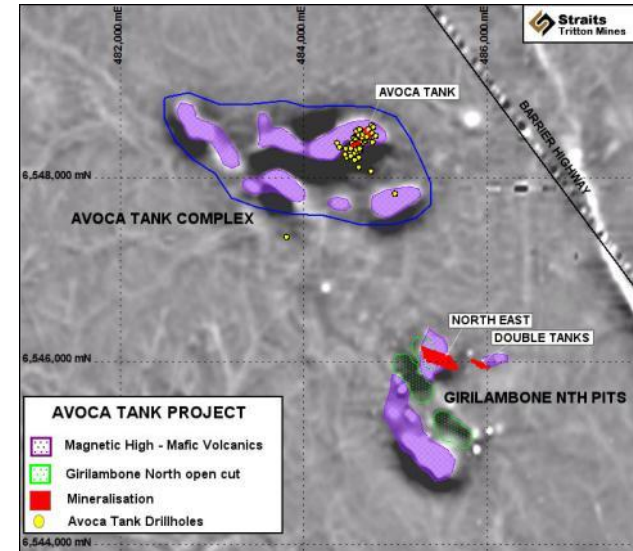



Mineral Resources

- ❑ The accompanying table sets out the current mineral resource inventory at Tritton Mines.
- ❑ Following the exploration drilling program in 2010/11, Measured and Indicated mineral resource mine life of 13 years was increased to 15 years, after production replacement, representing a discovery / conversion of 75,000 tonnes of Inferred Resource copper to Indicated level.

<i>TRITTON MINES, MINERAL RESOURCES AS AT 30 JUNE 2011</i>						
	COG	UNITS	MEASURED	INDICATED	INFERRED	2011 SRL
TRITTON	0.6	KTonnes	1,758	10,330	4,151	16,240
		Grade Cu	2.50	1.61	1.34	1.6
		Metal Cu	43,940	166,200	55,800	266,000
TRITTON PILLARS		KTonnes	496	304		800
		Grade Cu	2.56	3.8		3.1
		Metal Cu	13,100	11,600		24,800
MURRAWOMBIE	0.6% Cu	KTonnes		6,242	1,190	7,431
		Grade Cu		1.4	1.2	1.36
		Metal Cu		87,000	14,200	101,200
NORTH EAST	0.6% Cu	KTonnes	370	366	546	115
		Grade Cu	2.1	2.1	1.64	2.81
		Metal Cu	8,000	7,600	8,950	3,200
LARSENS	0.6% Cu	KTonnes		809		809
		Grade Cu		1.8		1.8
		Metal Cu		14,600		14,600
BUDGERYGAR	0.8% Cu	KTonnes			1,613	1,613
		Grade Cu			1.5	1.5
		Metal Cu			24,300	24,300
BUDGERY	0.5% Cu	KTonnes		1,720	270	1,986
		Grade Cu		1.1	0.93	1.08
		Metal Cu		18,900	2,470	21,400
TOTAL		KTonnes	2,620	19,950	7,336	29,908
		Grade Cu	2.47	1.54	1.36	1.58
		Metal Cu	64,700	307,300	100,000	472,000

Mining Operations





Mining Areas

- ❑ Tritton Mines currently operates at three mining areas, Tritton, Girilambone and Girilambone North.
- ❑ The Tritton mining area comprises the Tritton Mine, concentrator, paste fill plant, main administration offices and warehouse.
- ❑ The Girilambone mining area comprises the :
 - Historical Murrawombie oxide open pit
 - Murrawombie Mine (underground decline, operations currently suspended)
 - Girilambone heap leach complex and copper cement plant.
 - Administration and mining offices, maintenance and satellite warehousing facilities
- ❑ The Girilambone North mining area comprises the:
 - Historical North East, Hartmans and Larsens oxide open pits
 - North East Mine (underground decline accessed from the Hartmans pit)
 - Larsens Mine (underground decline and accessed from the North East decline)
 - The historical North East, Hartmans and Larsens and open pits
 - Avoca Tank development project

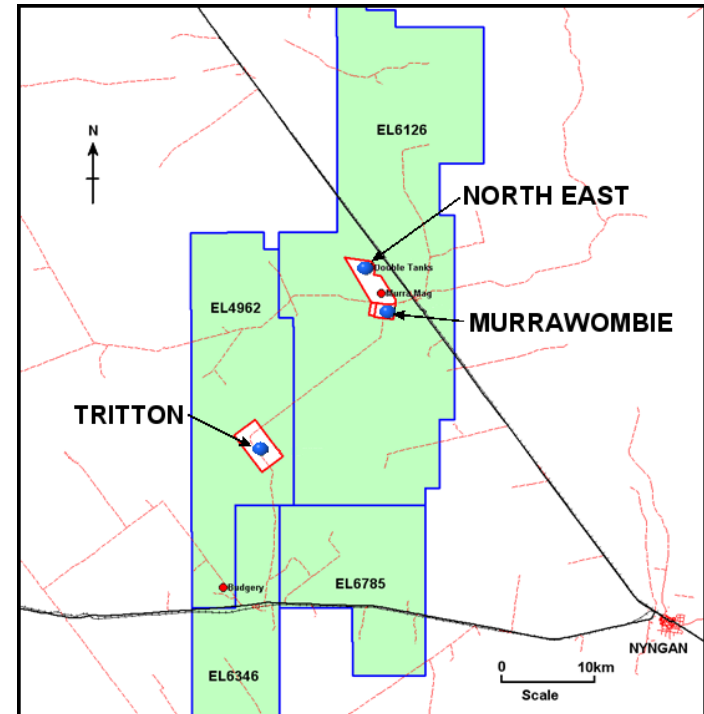



Mining Operations – Tritton Mine

- ❑ The Tritton Decline mine is a conventional mechanised underground operation utilising
 - Caterpillar R2900 LHD's
 - Tamrock DD420 – 60 Jumbo's
 - Atlas Copco M2D Jumbo's
 - Cat 980H and 972 FEL's
 - Sandvik DL420 Production Drills
 - Normet Charge Up Unit 1610B
 - Cat IT28G's
 - Cat AD55 Trucks

- ❑ The mining system has recently changed in 2011 from longitudinal open stoping with partial backfill to transverse open stoping with paste fill, with primary and secondary stopes accessed from a footwall extraction drive

- ❑ The recent change of mining method is planned to:
 - lift long term mine recoveries from ~63% to ~95%
 - underpin production levels of 1.1 Mtpa through increased stoping options and debottlenecking
 - Increase mine development capital investment return, and
 - decrease capital development per ore tonne extracted

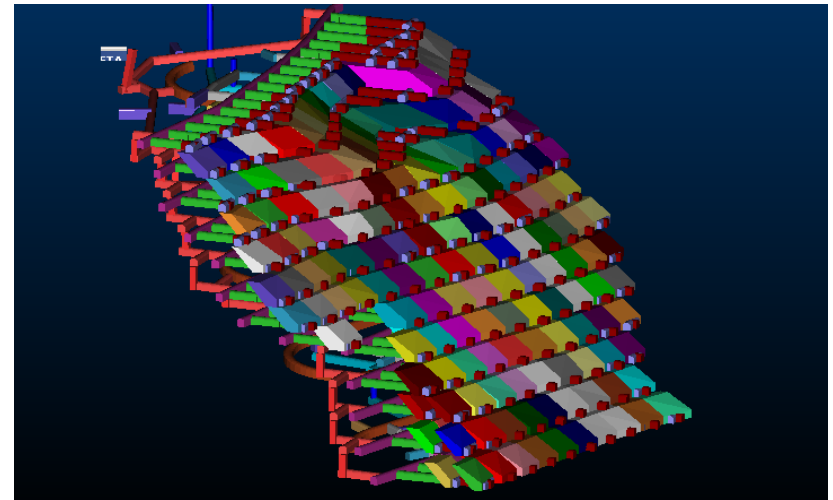



Mining Operations – Tritton Mine

- ❑ The Tritton Decline mine is a conventional mechanised underground operation utilising transverse LHOS (uphole retreat benching) methods in primary and secondary stopes, with paste fill and footwall stope access. Longitudinal LHOS may be used on the extremities.

- ❑ Mine Design Criteria
 - Declines and Cross cuts 5.5 mH x 5.5 mW
 - Decline gradient 1:7
 - Decline curvature 15 m
 - Decline standoff 50 m
 - Decline access Tritton box cut
 - Ore drives 5.0 mH x 5.0 mW
 - Level interval 40 metres
 - Ground support split sets, mesh and shotcrete. Cables in spans and drawpoints

 - Return airway 3 m diameter
 - Mine recovery ~95% of planned
 - Planned dilution 5 – 10%
 - Ore haulage to Tritton n/a

- ❑ Planned Mine Production rate p.a.

	2013FY	2014FY
▪ Tonnes	1,100,000	1,200,000
▪ Grade Cu%	2.09	1.93
▪ Cu Tonnes	23,133	23,067





Mining Operations – North East Mine

- ❑ The North East Decline mine is a conventional mechanised underground operation utilising longitudinal LHOS (uphole retreat benching) methods

- ❑ Mine Design Criteria

- Declines and Cross cuts 5.5 mH x 5.5 mW
- Decline gradient 1:7
- Decline curvature 15 m
- Decline standoff 40 m
- Decline access Hartmans pit
- Ore drives 5.0 mH x 5.0 mW
- Level interval 20 metres
- Ground support split sets, mesh and shotcrete. Cables in spans and drawpoints
- Return airway 3 m diameter
- Mine recovery ~95% of planned
- Planned dilution 5 – 10%
- Ore haulage to Tritton 27 km

- ❑ Planned Mine Production rate p.a.

	2013FY	2014FY
▪ Tonnes	342,090	326,300
▪ Grade Cu%	1.44	1.43
▪ Cu Tonnes	4,920	4,675

- ❑ The mine was restarted in October 2009 and is currently operating at 450,000 to 480,000 tpa.

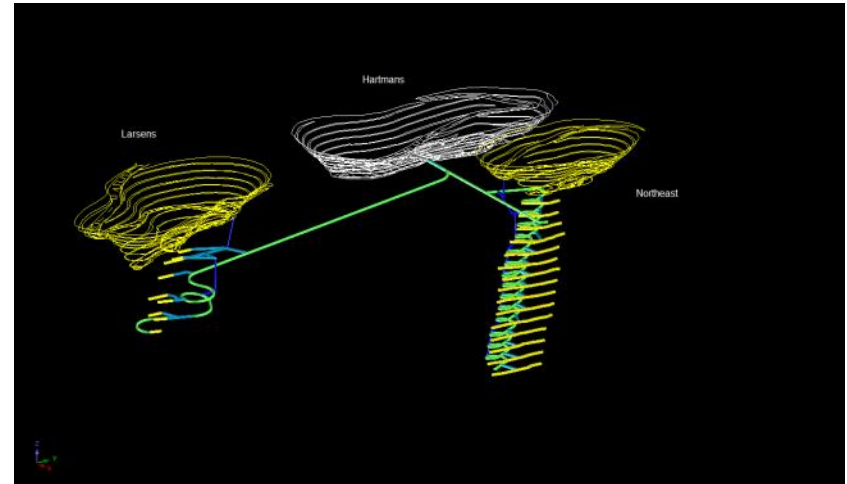



Mining Operations – Murrawombie Mine

- ❑ The Murrawombie Decline mine will be a conventional mechanised underground operation utilising longitudinal LHOS (uphole retreat benching) methods.

- ❑ Mine Design Criteria
 - Declines and Cross cuts 5.7 mH x 5.5 mW arched
 - Decline gradient 1:7
 - Decline curvature 20 m
 - Decline standoff 40 m
 - Decline access Murrawombie pit
 - Ore drives 5.0 mH x 5.0 mW arched
 - Level interval 10 - 20 metres
 - Ground support split sets, mesh and shotcrete. Cables in spans and drawpoints

 - Return airway 3 m diameter
 - Mine recovery ~93% of planned
 - Planned dilution 1.0m HW, 1.0m FW
 - Ore haulage to Tritton 22 km

- ❑ Planned Mine Production rate p.a.

	2015FY	2016FY
▪ Tonnes	425,500	513,900
▪ Grade Cu%	1.50	1.77
▪ Cu Tonnes	6,370	9,120

- ❑ Decline development commenced in February 2008 and advanced to within 10 metres of the first ore drive when it was suspended in November 2008 due to the GFC.

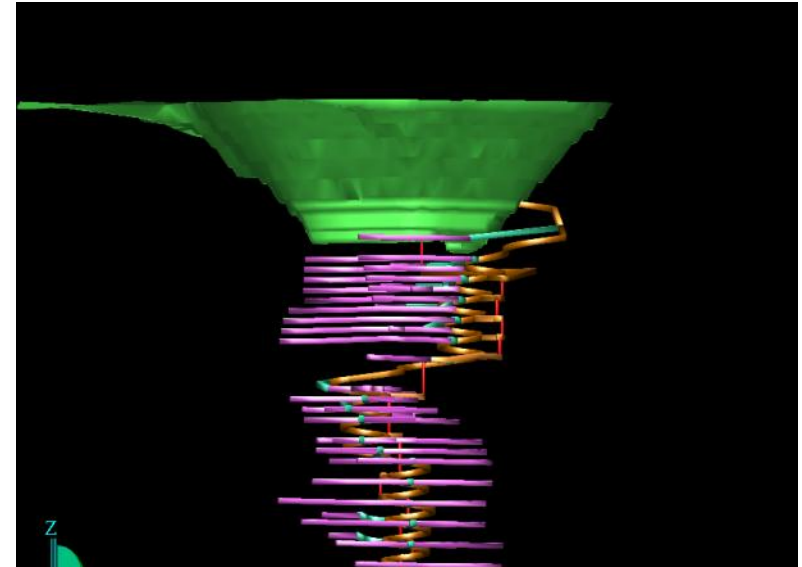



Ore Reserves

Ore Reserves as at 30 June 2011

- ❑ Ore reserves currently stand at 10.4 Mt at 1.80 % Cu for 172,000 tonnes of recovered copper.
- ❑ On current planning, this equates to a minimum 7 year mine life.
- ❑ Assumptions
 - Long term USD Cu 4.00 / lb
 - Long term USD:AUD 0.90
 - Ave Mine Recovery – 95%
 - Metallurgical Rec – 94.0%
 - Mine CoG – 1.0 – 1.2% Cu

MINE	Classification	Tonnes (Tonnes)	Copper Grade (%)	Recovered Copper (Tonnes)
TRITTON	Proved	1,400,000	2.40	32,000
	Probable	6,520,000	1.70	102,000
	Total	7,920,000	1.80	134,000
NORTH EAST	Proved	270,000	1.90	5,000
	Probable	410,000	1.50	6,000
	Total	680,000	1.60	11,000
MURRA	Proved			
	Probable	1,490,000	1.60	23,000
	Total	1,490,000	1.60	23,000
LARSENS	Proved			
	Probable	310,000	1.50	4,000
	Total	310,000	1.50	4,000
TOTAL	Proved	1,670,000	2.30	37,000
	Probable	8,730,000	1.60	135,000
	Total	10,400,000	1.80	172,000

- | Planned dilution | Footwall | Hangingwall | Mine Recovery |
|------------------------|----------|-------------|---------------|
| ▪ Tritton Proven | 5 – 10 % | 5 – 10% | 95% |
| ▪ North East Proven | 5 – 10% | 5 – 10% | 95% |
| ▪ Tritton Probable | 0.5 m | 0.5 m | 95% |
| ▪ North East Probable | 0.5 m | 0.5 m | 95% |
| ▪ Murrawombie Probable | 1.0 m | 1.0 m | 93% |
| ▪ Larsens Probable | 1.0 m | 1.0 m | 80% |



Mining Operations – Costs

- Benchmarking of the anticipated Tritton LOM (mine) operating costs against the AMC Consultants Benchmark Database, based on the three years of full production from 2011/12 to 2013/14 places Tritton consistently with its peers.

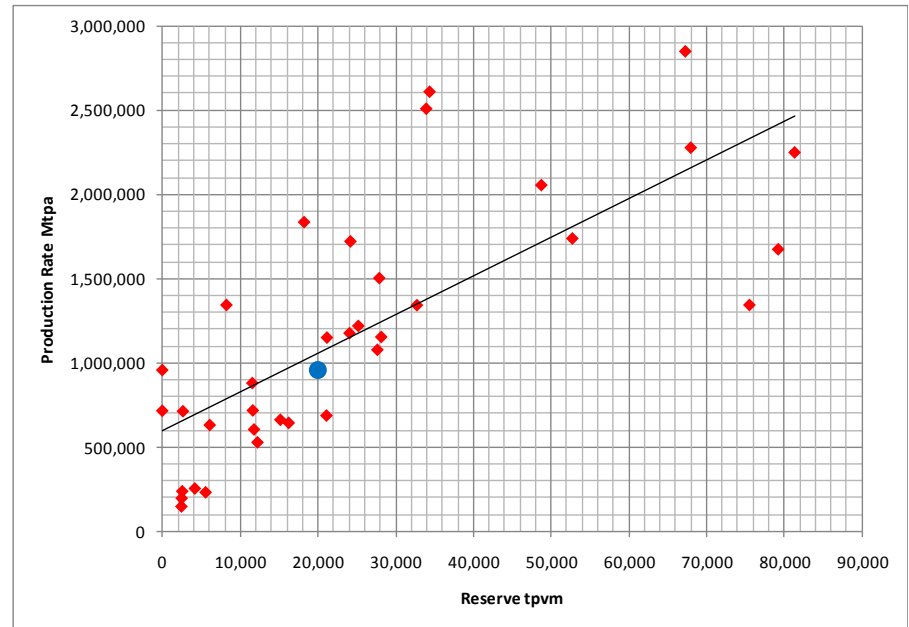

Processing





Processing Operations

- ❑ The Tritton processing plant was designed by Ausenco and commissioned in 2005 with a nameplate capacity of 900,000 tpa. Plant has capacity of 1.6 Mtpa rate.
- ❑ The crushing circuit comprises an ore bin with a fixed 800 mm aperture grizzly, feeding ore via a vibratory feeder to a Kemco S7N single toggle jaw crusher with a feed opening of 1.22 x 1.02 m
- ❑ Crushed ore of P₈₀ 100mm is conveyed to a 6,000 tonne stockpile where it is reclaimed via three vibrating feeders.
- ❑ Grinding comprises an ANI Ruwolt fixed speed high aspect 6.7m dia X 2.13, 1500 kW SAG Mill, discharging via a trommel screen to the secondary grinding circuit. Lime is added at the SAG to target pH 10.5 for pyrite suppression.
- ❑ Secondary grinding comprises a Marcy 3.81 m dia x 5.18 m 1250 kW ball mill operating in closed circuit with 500 mm dia Linatex hydrocyclones. Cyclone overflow discharges to two parallel Metso Vertimills (VTM800STD) installed as part of the TEP and shown in the foreground of the lower photo.
- ❑ Each Vertimill is in closed circuit with 250mm dia tertiary hydrocyclones.

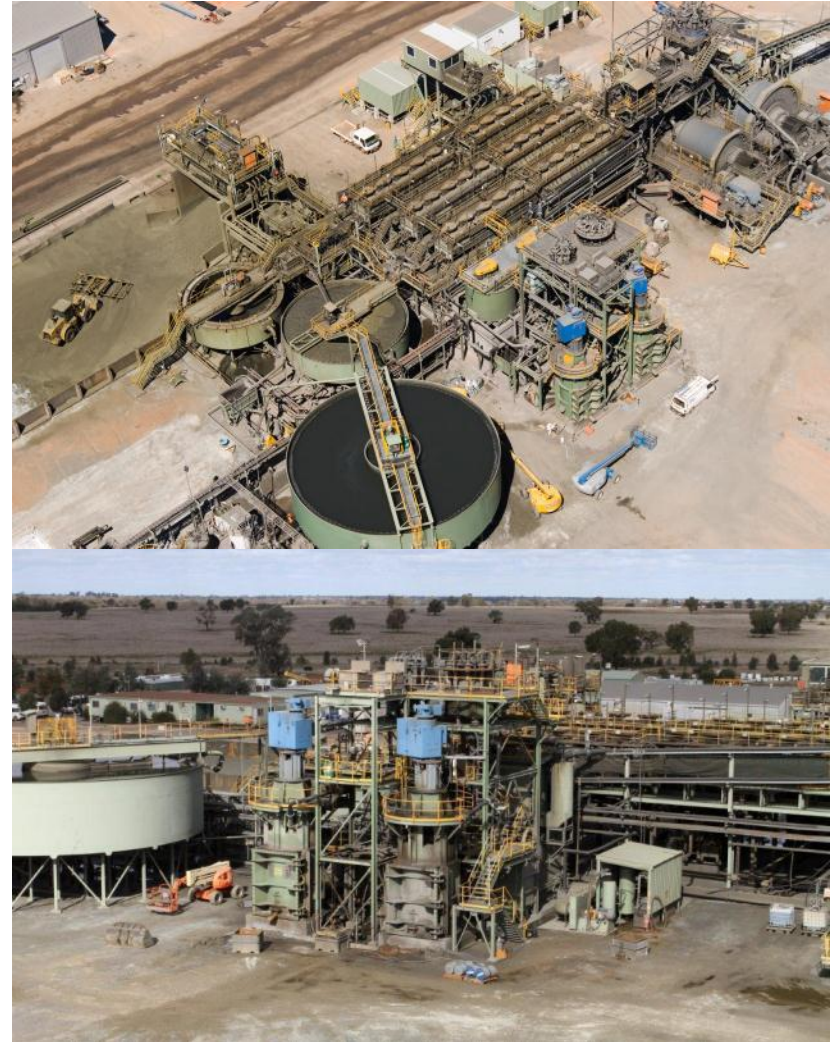



Processing Operations

- ❑ The grinding circuit produces a cyclone overflow product of P₈₀ 75 µm at 30 to 35% w/w solids.
- ❑ Total grinding circuit power draw is 3,160 kW.
- ❑ The tertiary cyclone overflow feeds two 50 m³ Wemco tank cells (installed as part of the TEP) in series for primary rougher flotation.
- ❑ Concentrate from the Wemco cells is directed to final concentrate recovering 70% of total copper.
- ❑ Primary rougher tails are pumped to conditioning tanks before two parallel banks of ten 8 m³ Dorr Oliver (5) rougher and (5) scavenger cells. Rougher concentrate is then sent directly to rougher cleaner while scavenger concentrate is sent to regrind.
- ❑ Regrind is achieved by a 2.0 m dia x 3.4 m 150 kW ball mill in closed circuit with Cavex hydrocyclones. The underflow reports to regrind and overflow to scavenger cleaner, rougher cleaner and final conc.
- ❑ The Tritton flotation circuit produces a copper concentrate typically with 25% Cu, <1 g/t gold and 30 g/t Ag from a mill feed of 2.1% Cu, 0.15 g/t Au and 6-7 g/t Ag.

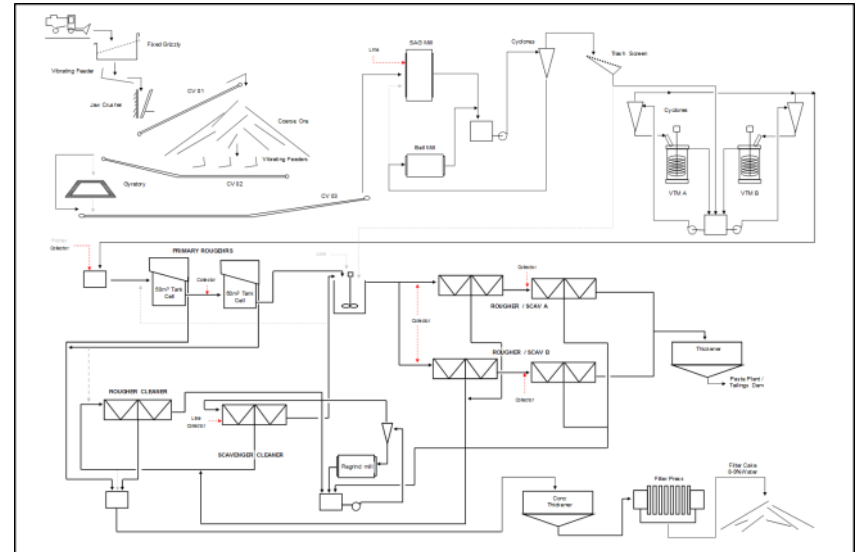

Tritton Plant Recoveries - 2011FY.

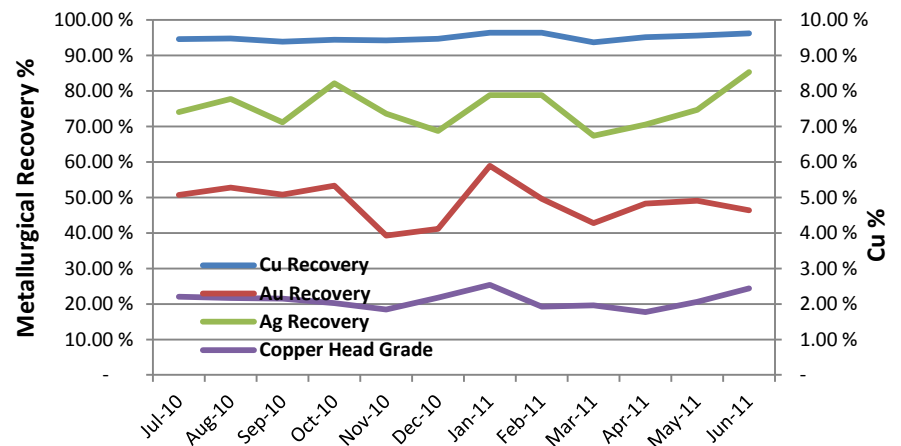



Processing Operations – Copper Cement

- ❑ Copper is recovered by cementation from the residual acidic copper solutions circulating in the Girilambone heap leach pads.
- ❑ Cementation exploits the difference in the electrochemical potential of iron and copper to recover copper from solution by replacing it with a more reactive element - iron.
- ❑ Scrap iron with a high surface area is used, to produce copper cement of 79 wt% Cu (59% dry)
- ❑ Three 14 m³ Kennecott Cones are used, which, when packed with iron in a batch process, allow contact between iron and acidic copper bearing solutions, and the recovery of copper cement to a product hopper.
- ❑ Product is filtered and bagged for dispatch.
- ❑ In its current configuration, the plant can produce 1,100 tpa of wet copper cement (620 tpa of copper metal).

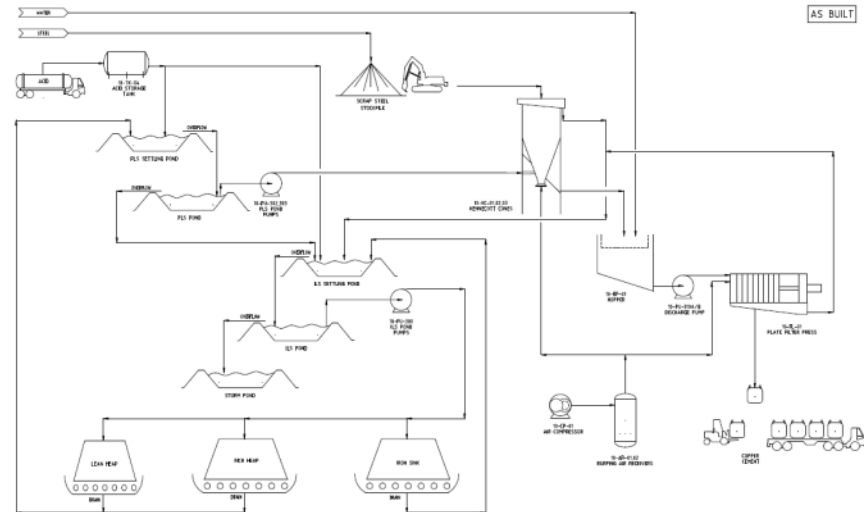

Infrastructure





Infrastructure - Pastefill

- ❑ Cement pastefill for introduction to mining voids at Tritton is manufactured from tailings from the processing plant. Blends of tailings and aggregate can also be used, as well as reclaimed tailings from the TSF.
- ❑ Paste, containing 2 to 7 % cement, is delivered underground and reticulated under vacuum by an underground network of pipes and cased drillholes to the primary or secondary stopes being filled.
- ❑ The filled primary stope void, once filled with paste which has cured, provides geotechnical stability and the ability to extract the adjacent secondary stopes.
- ❑ Secondary stopes are filled following extraction also, to provide overall mine stability, although typically a lesser strength (2-3% cement) paste is used.
- ❑ This mining system delivers mining recoveries of ~95%.
- ❑ The Tritton pastefill plant was constructed during the second half of 2010 at a cost of A\$15 million, and was commissioned on time and budget in January 2011.





Infrastructure

- ❑ Power and water are supplied to the Tritton mining areas from infrastructure originally installed for the Girilambone site.
- ❑ Power is supplied from the Nyngan-Bourke 66kV transmission line which was extended from Girilambone to the Tritton site.
- ❑ The Tritton and Girilambone/North East sites currently use approximately 9MVA of total power, and the grid is able to provide an additional 4.5MVA for future expansions.

Site Power Capacity	Current (MVA)	Additional (MVA)	Total (MVA)
Girilambone	1.5	1.4	2.9
Tritton	7.5	3.2	10.7
TOTAL	9.0	4.6	13.6

- ❑ Tritton Mines employs about 300 full time employees and 65 contractors. They are employed on a variety of roster arrangements, including fly in/out, drive in/out and residential.
- ❑ Housing is provided in Nyngan for residential employees, and the Company also offers motel style accommodation in a 32 room village in Nyngan (right). The Company owns eleven houses and four additional blocks of land in the town.

- ❑ Water is pumped from the Gunningbar Creek, 22km east of Girilambone, via a storage dam at Girilambone, to the Tritton site.
- ❑ Tritton Mines currently uses about 60% of the total water allocation held under the site licenses.

Water License	Volume (ml)
Regulated Water (High Security)	705
Regulated Water (General Security)	201
Supplementary Water	16
TOTAL	922



Marketing





Marketing

- ❑ Tritton sells its copper concentrate under a copper offtake agreement to J.P. Morgan Metals and Concentrates LLC of Connecticut, USA, formerly known as Sempra Metals and Concentrates.
- ❑ Prior to today the contract since inception has been extremely onerous in terms of TC/RC's. In December 2011 finalised a new agreement with JP Morgan (from January 2012) based on normal market terms. The cost of terminating the old agreement was US\$98 million.
- ❑ In addition, Tritton will have the option to terminate the new offtake agreement with J.P. Morgan with effect from 1 July 2012, for an option fee of US\$9 million.
- ❑ On the back of the re-capitalised Tritton operation, and a minimum 7 year reserve mine plan (15 year resource plan) delivering 25,000 tpa of copper in concentrate, on the assumption that the option above is exercised Tritton intends to enter into a tender process for the sale of its concentrate at market terms from 1 July 2012.
- ❑ The Tritton concentrate is an extremely clean concentrate and highly valued by traders and end users due to its ability to be used as a blending agent to improve poorer quality concentrates so as to meet smelter terms.
- ❑ Concentrates are sold on a CIF basis with exports out of Newcastle.

Current Indicative Concentrate Quality

Element	Assay	Element	Assay
Copper %	25	SiO ₂ %	8
Gold g/t	0.7	MgO %	2
Silver g/t	50	As ppm	80
Fe %	28	Bi ppm	4
S %	31	Cd ppm	70
Zn %	1.5	F ppm	120
Ni ppm	33	Hg ppm	2
Co ppm	300	Sb ppm	40
Cl ppm	120	Se ppm	165

Health, Safety and Environment





Health, Safety and Environment

- ❑ The Tritton Mines Health, Safety and Environment (HSE) system is based on Straits' Corporate HSE policies and a framework of HSE Management System Standards (MSS), Environmental Performance Standards (EPS) and Safety Performance Standards (SPS).
- ❑ The site has developed a variety of management plans and procedures to implement the requirements of the Corporate standards as well as State and Commonwealth legislative obligations.
- ❑ The standard HSE metrics of Lost Time Injury and Total Recordable Injury Frequency Rates are shown right.

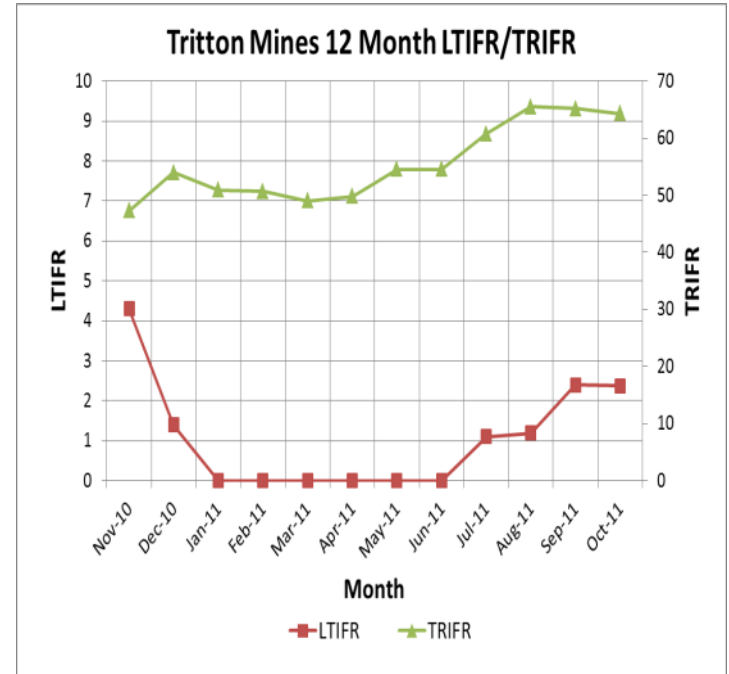



Health, Safety and Environment

- ❑ The Corporate HSE Standards are aligned with Australian and International standards. The scope of these standards is shown below.

Management System Standards

Leadership, Commitment and Accountability
Legal Compliance and Document Control
Objectives, Planning and Resources.
Risk and Change Management
Training, Competence and Authorisation
Health and Hygiene
Communication and Engagement
Contractors, Suppliers and Partners
Operational Control
Business Continuity / Emergency and Crisis Management
Incident Management
Monitoring, Assessment and Improvement

Safety Performance Standards

Fitness for Work
Mobile Equipment Operation
Electrical Safety
Isolation and Lockout
Confined Space
Working at Heights
Lifting and Supporting Loads
Hazardous Materials and Dangerous Goods
Explosives
Mobile Equipment Condition

Environmental Performance Standards

Hydrocarbon Management
Chemicals Management
Contaminated Sites Management
Energy Management
Near Mine Exploration
Tailings Management
Water Management
Waste Rock and ARD Management
Non Process Waste Management
Closure Planning and Management
Land Rehabilitation
Dust Management
Biodiversity Management
Noise and Vibration Management
Heap Leach Management
Visual Impact
Cyanide Management
Environmental Approvals

Business Plan





Business Plan

- ❑ Straits strategy at Tritton is to leverage growth by drawing on our capital investment in the region, our installed infrastructure, our established counterparty and local relationships but more importantly our established position with respect to the latent geological opportunity now revealing itself.
- ❑ In the short term, stabilise production at 1.4 Mtpa and 25,000 tpa copper in concentrate.
- ❑ Explore and extend resources to maintain and replenish production.
- ❑ Target incremental bolt on increase of 300,000 to 400,000 tpa from new sources and debottlenecking of plant to achieve 1.7 to 1.8 Mtpa throughput and 32,000 to 34,000 tpa of copper in concentrate
- ❑ Greenfields discovery target of additional 10 million tonnes at 2.0% Cu, remote or under the headframe, from existing identified targets.
- ❑ Continue to convert and improve resource value, from prospect, to inferred resource, to measured and indicated resources.

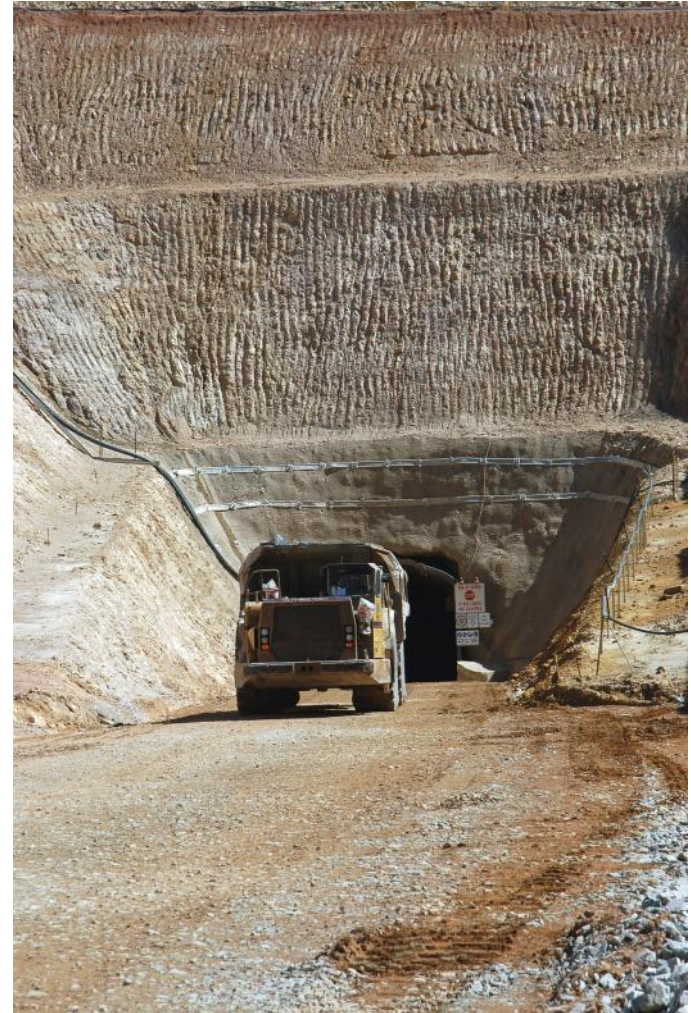



Business Plan - Exploration

- ❑ **Exploration Based Growth**
- ❑ Due to a variety of reasons, until recently exploration drilling and budgets have largely been focused on under the headframe extensional drilling and resources definition at the known deposits of Tritton, Murrawombie, North East and Larsens.
 - Pre 1995, Exploration focused solely on copper oxides
 - Post 1995, budgets and drilling focused on Tritton and northern mine sulphides.
- ❑ More recently, we have developed a greater geological understanding of the Besshi style mineralisation and its genesis, and accordingly have developed more robust models and exploration programs, which are identifying the potential for discovery of new clustered VMS systems within the permit area.
- ❑ Regional IP programs implemented in September 2011 coincident with detailed magnetics over old oxide targets are revealing new VMS clusters at Avoca Tank.
- ❑ This exploration strategy will be rolled out over all known oxide targets and prospects, some with known ore grade (oxide) mineralisation.

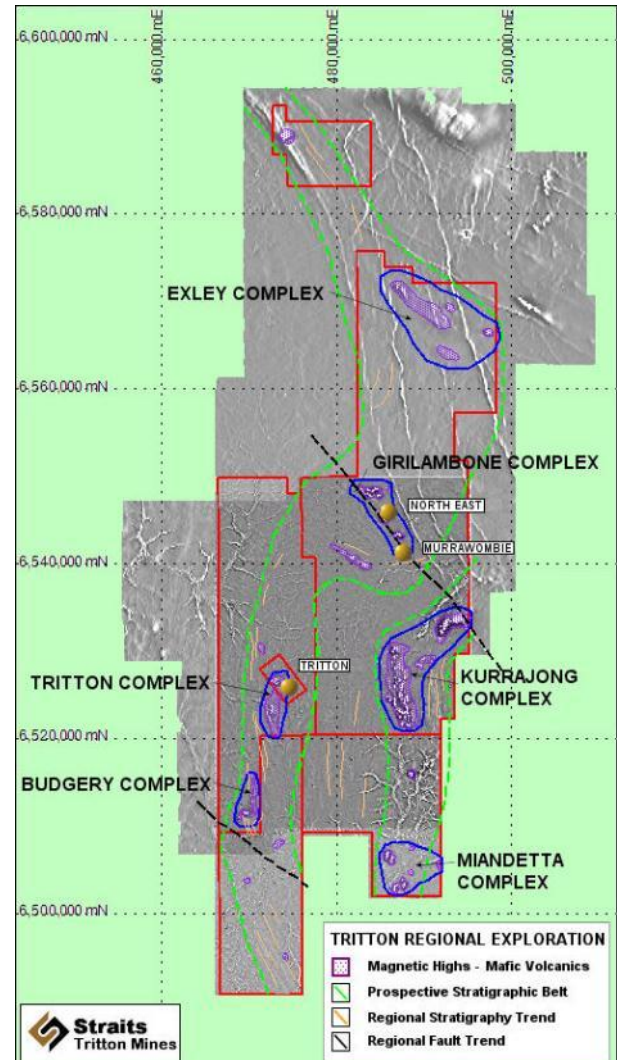



Business Plan – Mining Improvements

- ❑ Straits has already executed much of its current business plan and has now established its base operating platform to deliver a minimum 25,000 tpa of copper in concentrate for ~7 years

- ❑ This includes
 - Implementation of the revised mining method at Tritton (transverse open stoping) which was commenced in October 2010. The first of the transverse stopes have now been fully mined.
 - Construction and commissioning of the paste fill plant, now fully operational
 - Commencement of mining operations at the North East mine, now exceeding its production targets of 350,000 tpa.
 - Transition from contract to owner operate mining at Tritton fully implemented in October 2011 is expected to realise an ~8% reduction in operating costs.
 - Introduction of a new truck fleet comprising five new Caterpillar AD55B underground trucks.
 - LOM planning for the recommencement of mining at Murrawombie in 2014.

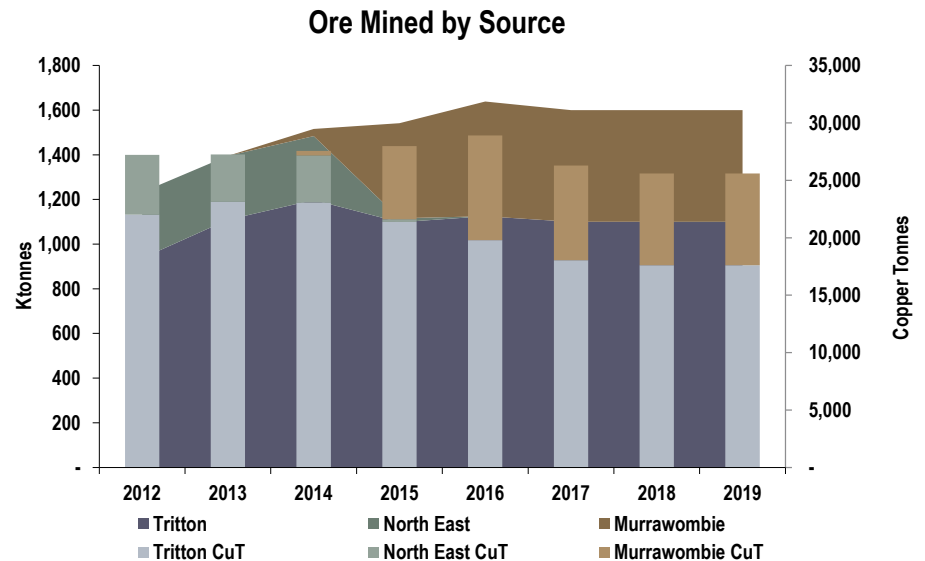



Business Plan – Processing Improvements

- ❑ Straits has initiated a number of expansion, efficiency and debottlenecking programs at Tritton, to improve recovery and to lift throughput capacity from 1.6 Mtpa to 1.8 Mtpa, essentially from existing installed capital.

- ❑ Throughput projects.
 - Upgrade crusher discharge and tramp metal removal system [in progress].

 - CV03 transfer design modifications. Modification of the CV02 to CV03 transfer flask to reduce blockage [in progress].

 - Re-engineering of SAG mill discharge end. Over 30% of the working area on the discharge gates are blanked off due to the design of the pulp lifters, a legacy issue. A new design has been engineered and the new pulp lifters will be installed mid 2012.

 - Upgrade the ball mill gear box. Currently the ball mill motor is rated at 1500kW, but the gear box is only rated to 1250kW and the mill charge level is restricted to 35% due to the level of the overflow discharge outlet. Increasing gear box size and installation of a retaining ring to rectify. Install in FY 2013.

 - Investigate Derrick screens to improve primary grind circuit classification to potentially increase efficiency from 60% to 90% and reduce recirculating load and overgrinding.

Cu Production and Cu Feed Grade

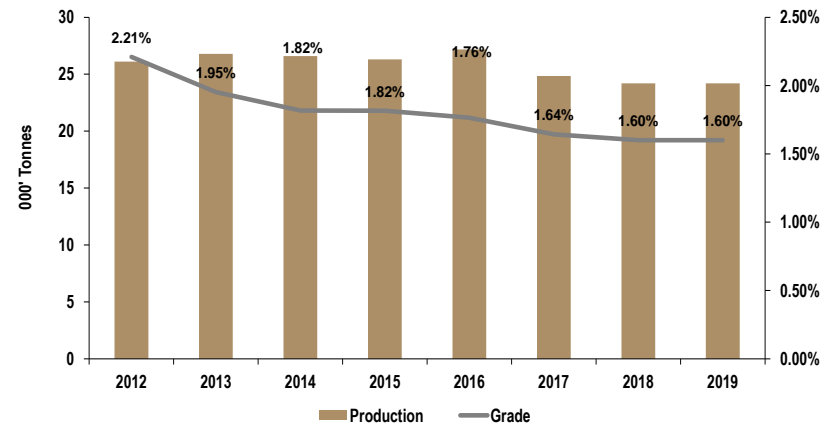

- ❑ Process recovery projects.
 - Grinding media size reduction. Simulations indicate reducing ball mill grinding media from 65mm to 50mm and the tertiary media from 30mm to 25mm will reduce particle size and grinding media consumption. Trial to be run mid 2012.

 - Gold – silver mineralogy testwork to improve precious metal recovery and possibly a standalone PM concentrate.

 - Ongoing hardness characterisation and grind size/flotation optimisation testwork.



Competent Person Statements

Competent Person Statement for Mineral Resources and Drilling Results:

The information in this presentation to Mineral Resources and Drilling Results is based on information compiled by Byron Dumpleton, who is a member of the Australian Institute of Geoscientists. Mr Dumpleton is a full-time employee of Straits Resources Limited and has sufficient experience relevant to the style of mineralisation, type of deposit under consideration and to the activity which he is undertaking to qualify as a Competent Person as defined in the 2004 Edition of the "Australasian Code for Reporting of Mineral Resources and Ore Reserves". Mr Dumpleton consents to the inclusion in the report of the matters based on his information in the form and context in which it appears.

Mineral Resources reported are inclusive of Ore Reserves.

Discrepancies in Resource Table summations may occur due to rounding.

Competent Person Statement for Ore Reserves:

The information in this presentation that relates to Ore Reserves is based on information compiled by Peter Storey, who is a member of the Australasian Institute of Mining and Metallurgy. Mr Storey is a full-time employee of Straits Resources Limited and has sufficient experience relevant to the style of mineralisation, type of deposit under consideration and to the activity which he is undertaken to qualify as a Competent Person as defined in the 2004 Edition of the "Australasian Code for Reporting of Mineral Resources and Ore Reserves". Mr Storey consents to the inclusion in the report of the matters based on his information in the form and context in which it appears.

Discrepancies in Reserve Table summations may occur due to rounding.